

REFRACTORY ANCHORS CATALOGUE

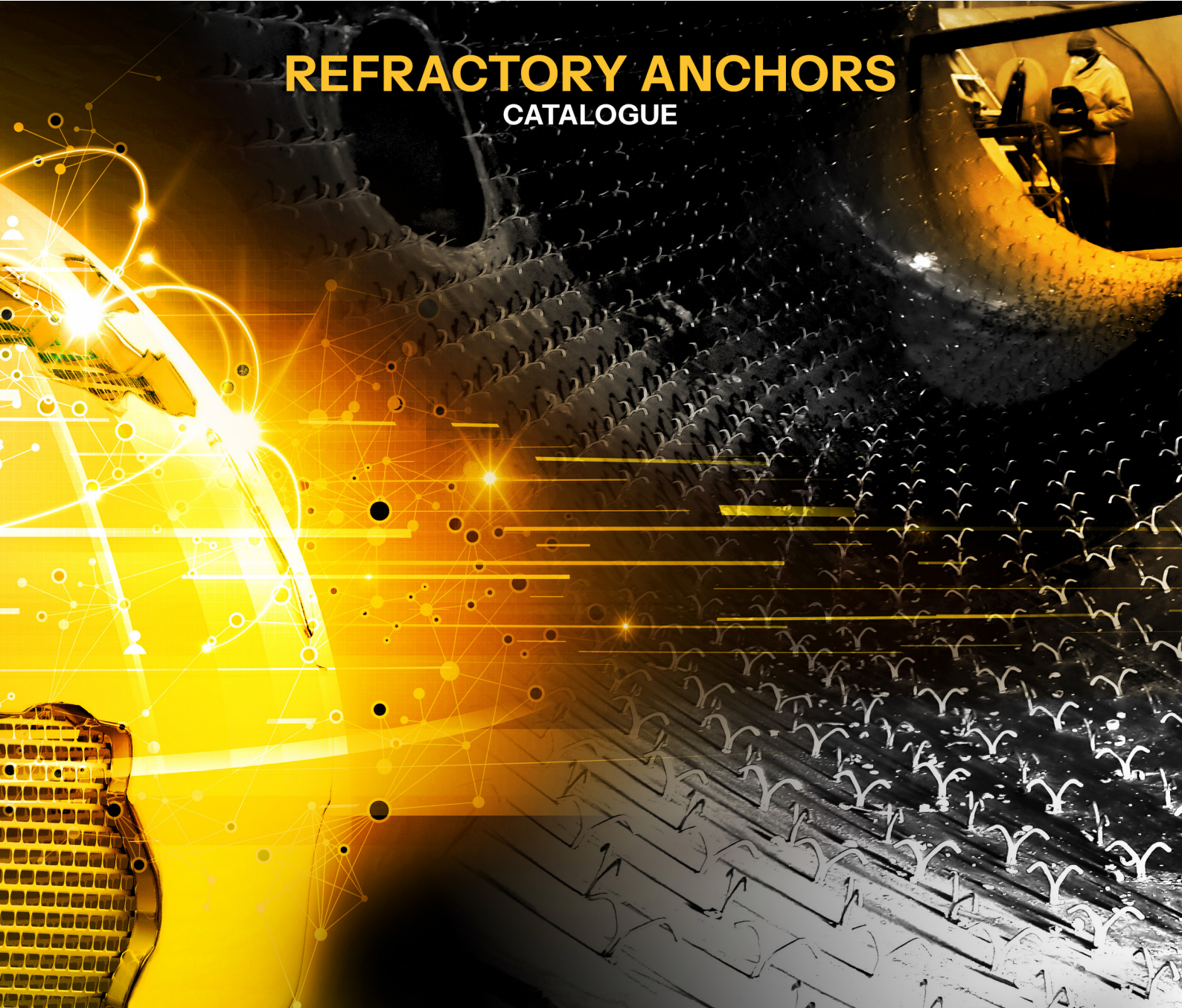

LEADING THE WAY
IN ASSET INTEGRITY MANAGEMENT & INDUSTRIAL SOLUTIONS

www.dgc-africa.com

SOUTH AFRICA

ZAMBIA

DEMOCRATIC REPUBLIC OF CONGO

MADAGASCAR

ZIMBABWE

BRAZIL

CHINA



DGC HAS BEEN
**DESIGNING,
MANUFACTURING
& INSTALLING
STANDARD,
CUSTOM-MADE
HIGH-QUALITY
REFRACTORY
ANCHORS**
AS WELL AS A
WIDE RANGE OF
ANCHOR SUPPORTING
SYSTEMS
**FOR MORE
THAN 35 YEARS.**

CONTENTS

01	GULL WING
02	VEE WRIGGLE
03	VEE
04	FIBRE LOCK PIN
05	BOX V
06	BULL HORN
07	V.X.D.B
08	V.X.C-SCISSOR CLIP
09	ROOF ANCHOR
10	CEMENT PLANT SPECIAL
11	“C” CLIP
12	R6P - SUSPENSION
13	Y ANCHOR

GULL WING

G.W.H.W

GULL WING HAND WELD

NOTES

Diameters Available: 5.5mm, 8mm, 10mm, 12mm

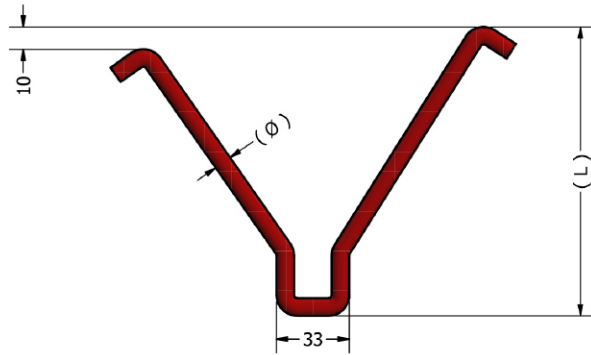

FRONT VIEW

3D VIEW

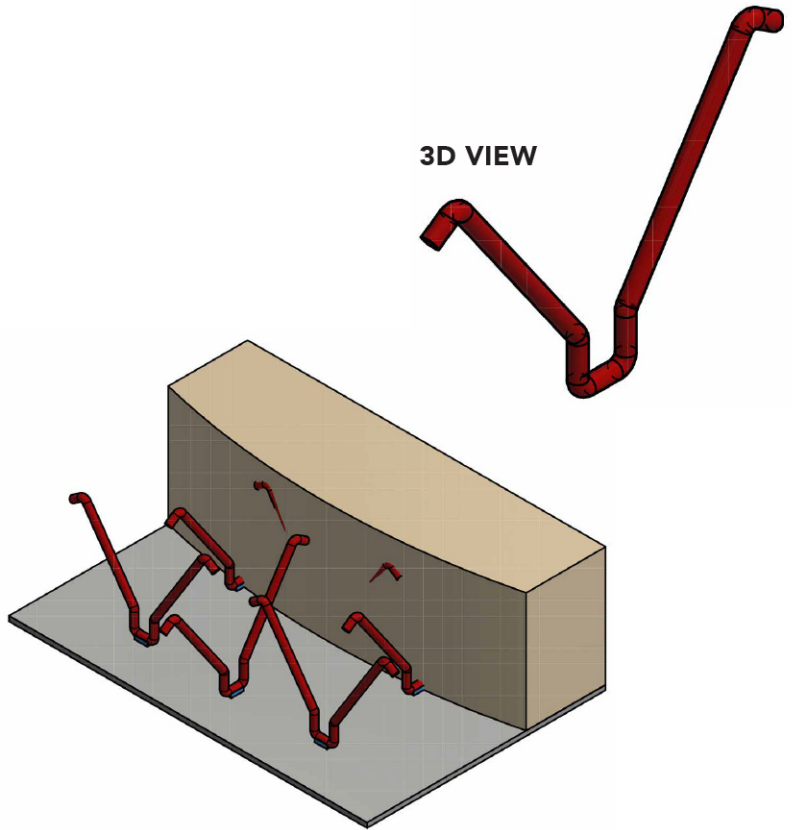

DESIGNATION

MANUFACTURED IN MILD STEEL

304 S/STL

316 S/STL

310 S/STL

253 MA

L = 25mm - 350mm

G.W.S.W

GULL WING STUD WELD

NOTES

Diameters Available: 5.5mm, 8mm

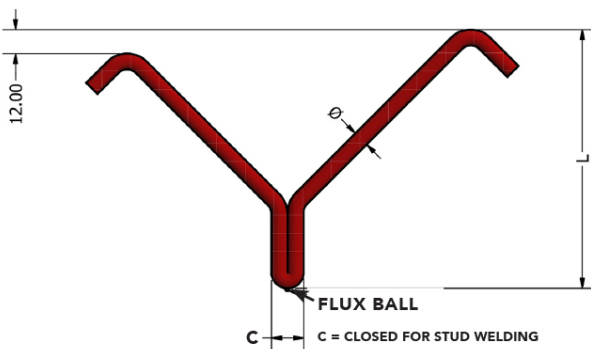

FRONT VIEW

3D VIEW

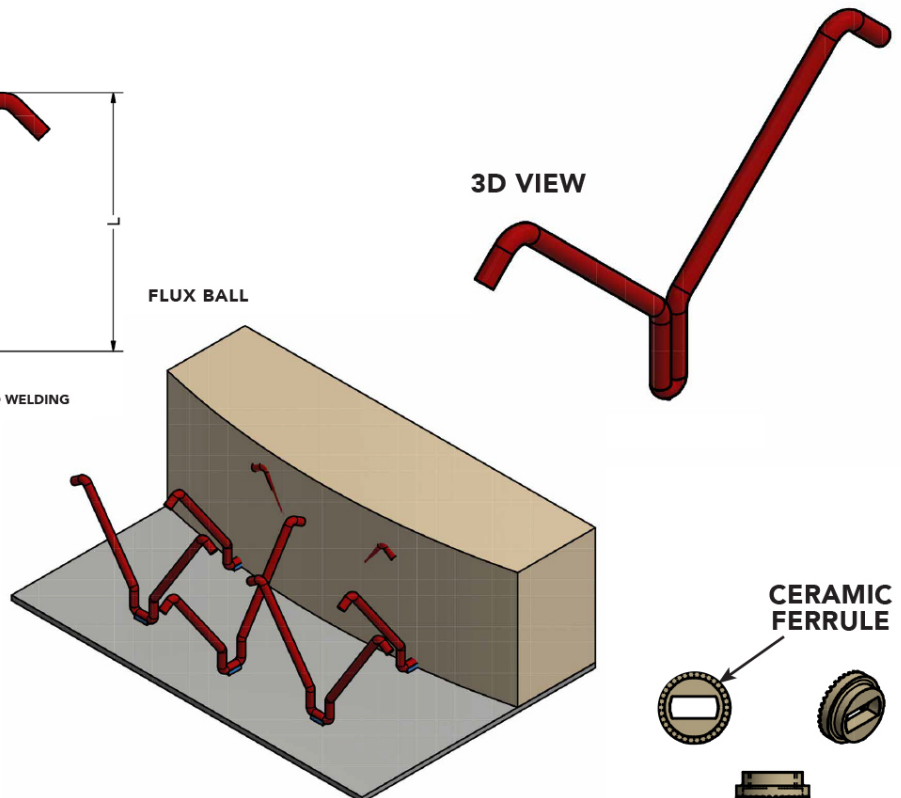

DESIGNATION

MANUFACTURED IN MILD STEEL

304 S/STL

316 S/STL

310 S/STL

253 MA

L = 25mm - 350mm

VEE WRIGGLE

V.X.H.W

VEE WRIGGLE HAND WELD

NOTES

Diameters Available: 5.5mm, 8mm, 10mm, 12mm

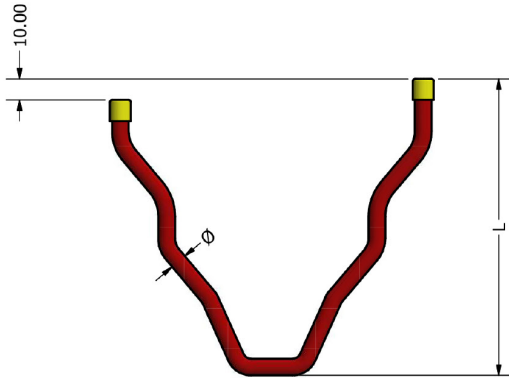

FRONT VIEW

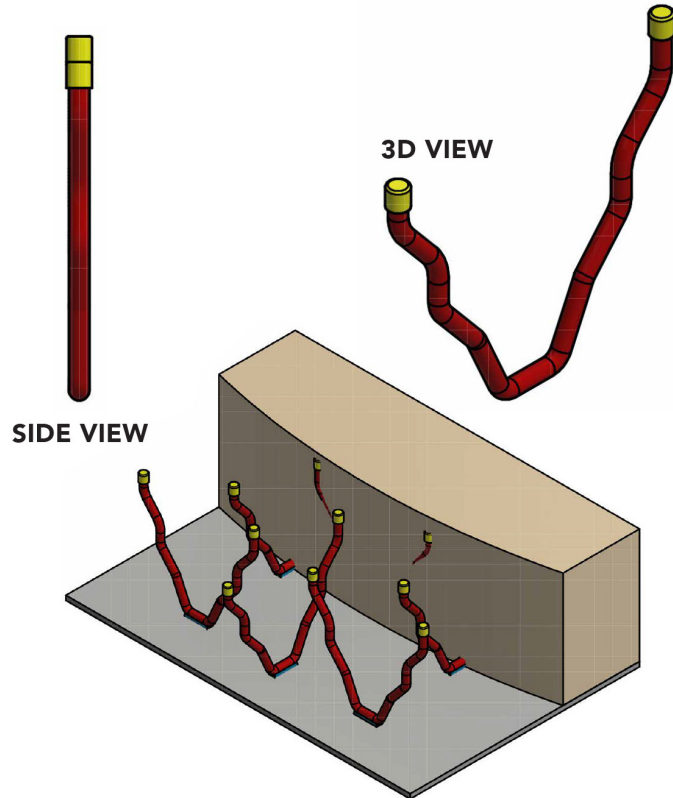

SIDE VIEW

3D VIEW

DESIGNATION

MANUFACTURED IN MILD STEEL

304 S/STL

316 S/STL

310 S/STL

253 MA

L = 25mm - 350mm

V.X.S.W

VEE WRIGGLE STUD WELD

NOTES

Diameters Available: 5.5mm, 8mm

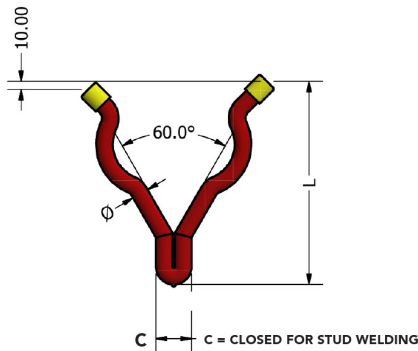

FRONT VIEW

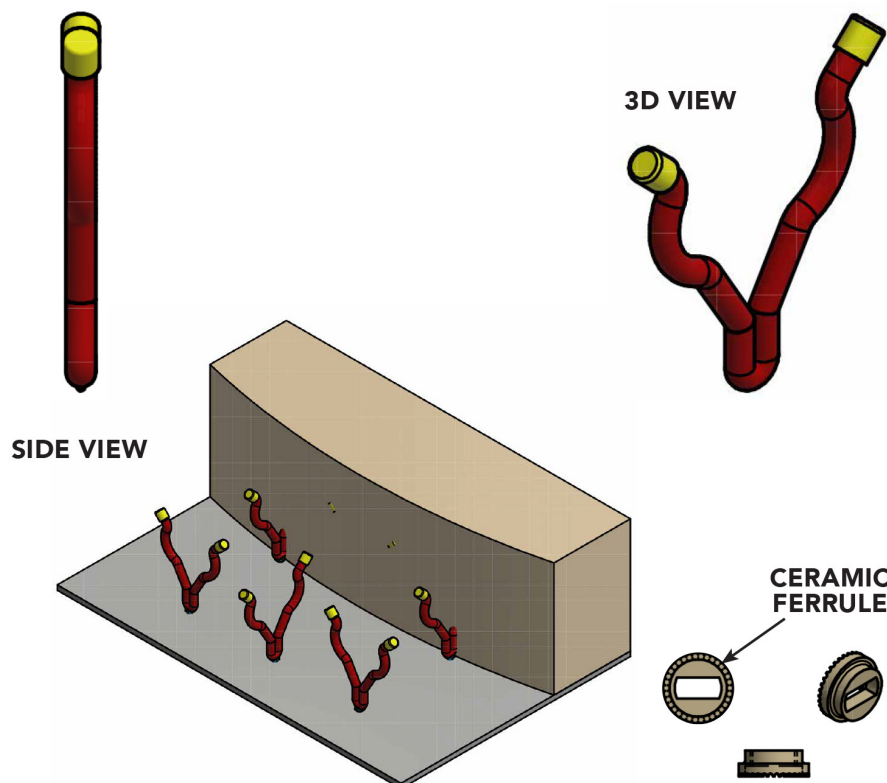

SIDE VIEW

3D VIEW

DESIGNATION

MANUFACTURED IN MILD STEEL

304 S/STL

316 S/STL

310 S/STL

253 MA

L = 25mm - 350mm

V.H.W

VEE HAND WELD

NOTES

Diameters Available: 5.5mm, 8mm, 10mm, 12mm

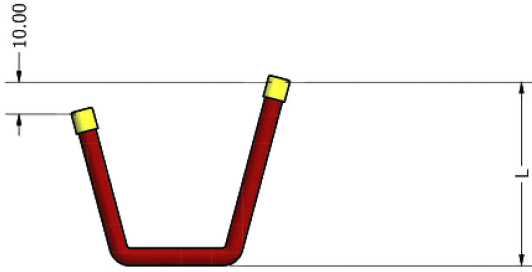

FRONT VIEW



SIDE VIEW

3D VIEW

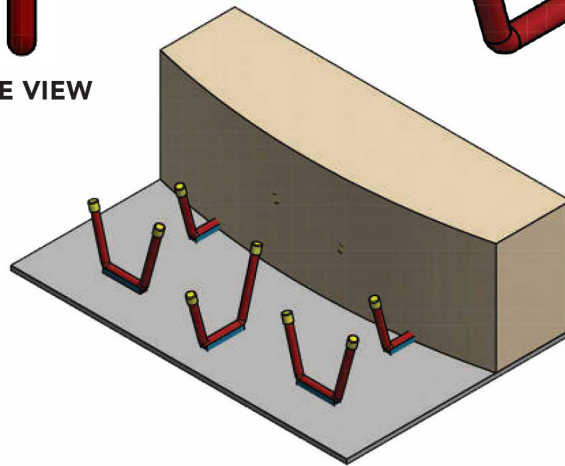
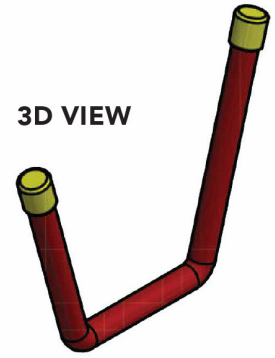

DESIGNATION

MANUFACTURED IN MILD STEEL

304 S/STL

316 S/STL

310 S/STL

253 MA

L = 25mm - 350mm

V.S.W

VEE STUD WELD

NOTES

Diameters Available: 5.5mm, 8mm

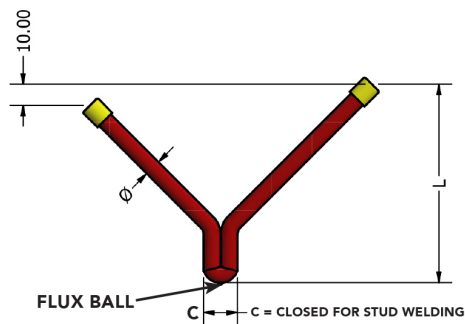

FRONT VIEW



SIDE VIEW

3D VIEW

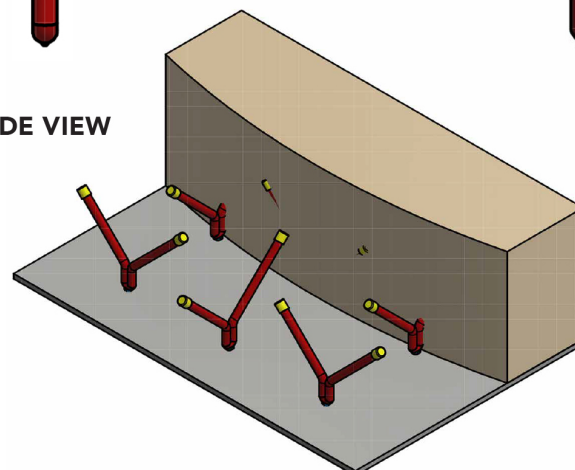
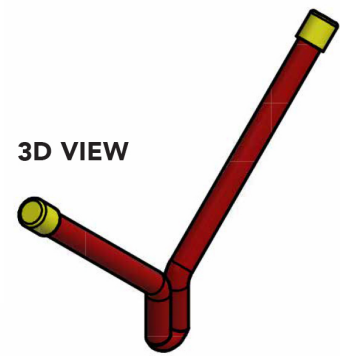

CERAMIC FERRULE

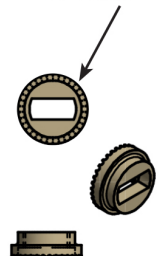

DESIGNATION

MANUFACTURED IN MILD STEEL

304 S/STL

316 S/STL

310 S/STL

253 MA

L = 25mm - 350mm

FIBRE LOCK PIN

FIBRE LOCK PIN

NOTES

Diameters Available: 5.5mm

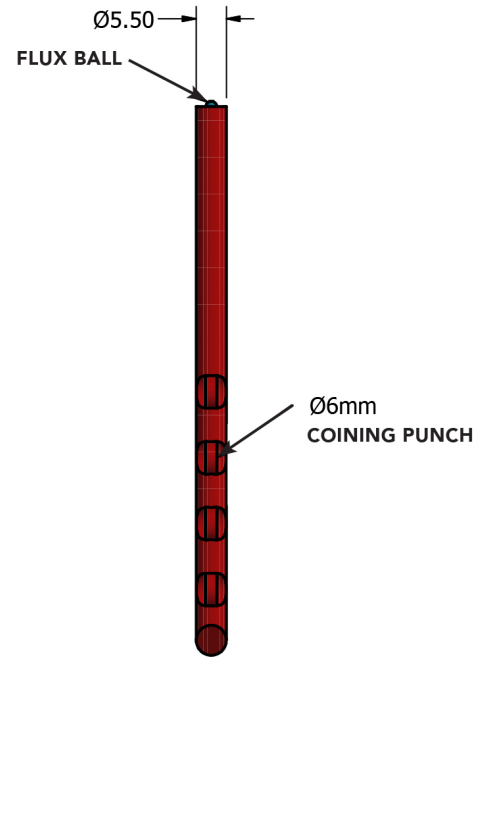
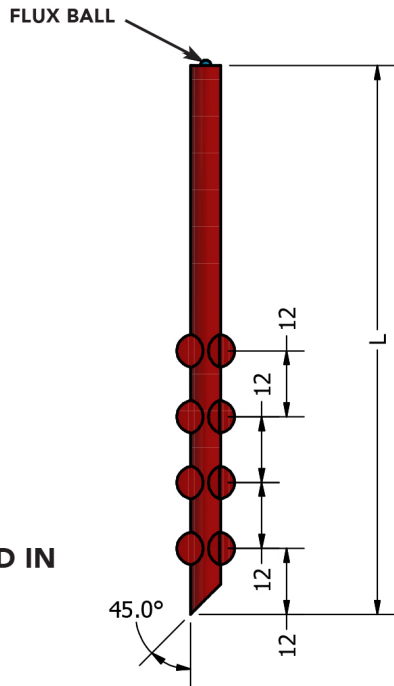

DESIGNATION

MANUFACTURED IN

304 S/STL

316 S/STL

310 S/STL

253 MA

L = 25mm - 350mm

LOCK WASHER FOR FIBRE LOCK PIN

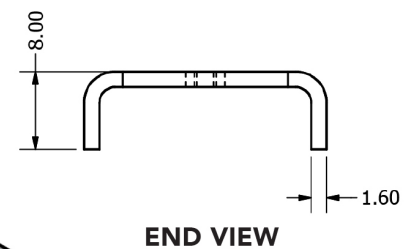
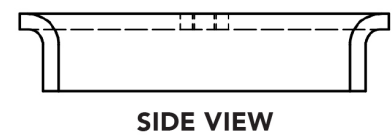
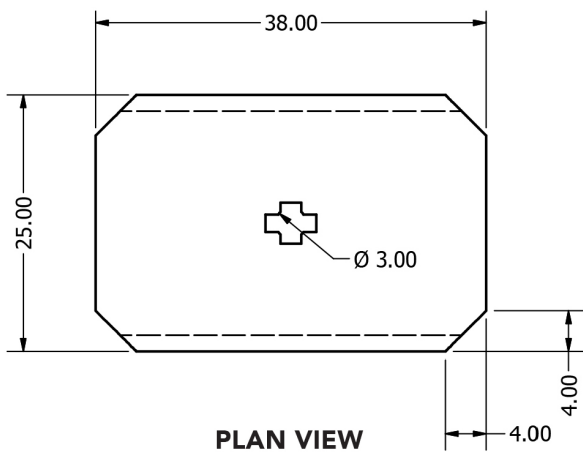

DESIGNATION

MANUFACTURED IN MILD STEEL

304 S/STL

316 S/STL

310 S/STL

253 MA

L = 25mm - 350mm

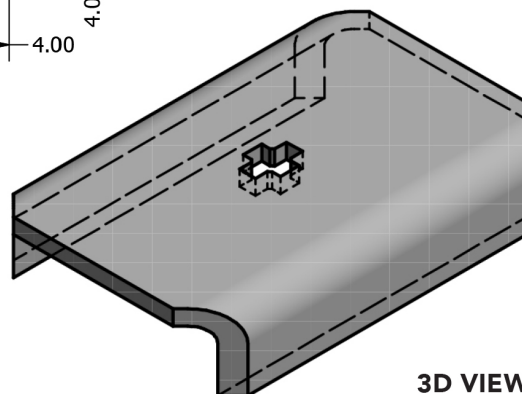

BOLT ON WRIGGLE VEE

NOTES

Diameters Available: 5.5mm, 8mm, 10mm, 12mm

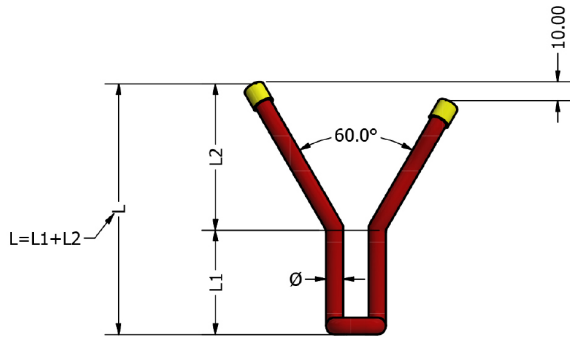

FRONT VIEW



SIDE VIEW



BOTTOM VIEW

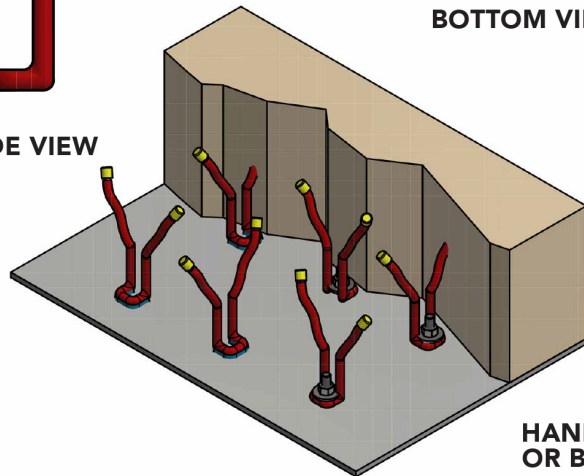

HAND WELD OR BOLT ON

DESIGNATION

MANUFACTURED IN MILD STEEL

304 S/STL

316 S/STL

310 S/STL

253 MA

L = 25mm - 350mm

BOLT ON WRIGGLE VEE

NOTES

Diameters Available: 5.5mm, 8mm, 10mm, 12mm

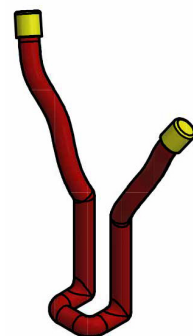
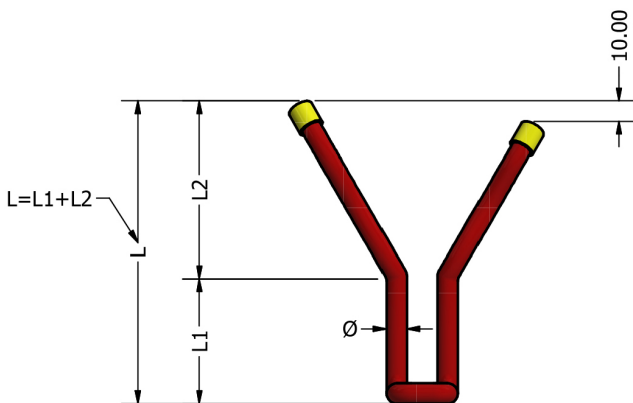

DESIGNATION

MANUFACTURED IN MILD STEEL

304 S/STL

316 S/STL

310 S/STL

253 MA

L = 25mm - 350mm

CERAMIC FERRULES



METRIC HEX NUTS STYLES 2 →



METRIC PLAIN WASHERS →



MB STUD →

FLUX BALL →

BULL HORN

B.H.H.W

BULL HORN HAND WELD

NOTES

Diameters Available: 5.5mm, 8mm, 10mm and 12mm

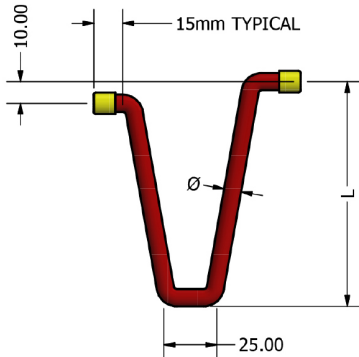

FRONT VIEW



SIDE VIEW

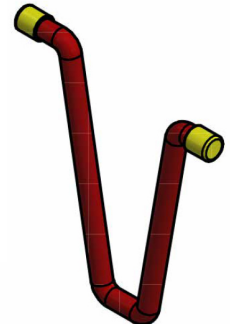

3D VIEW

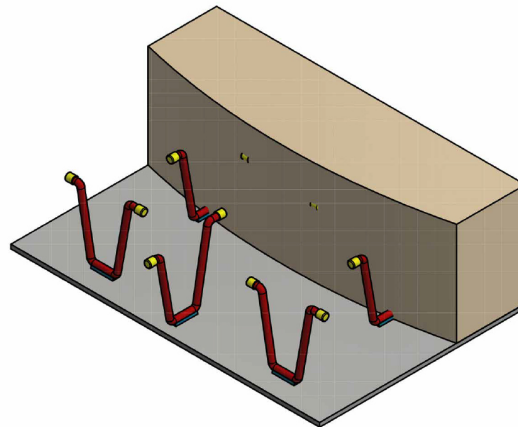

DESIGNATION

MANUFACTURED IN

- 304 S/STL
- 316 S/STL
- 310 S/STL
- 253 MA

L = 25mm - 350mm

B.H.S.W

BULL HORN STUD WELD

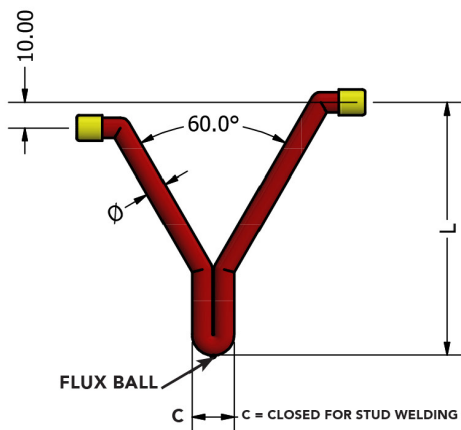

FRONT VIEW



SIDE VIEW

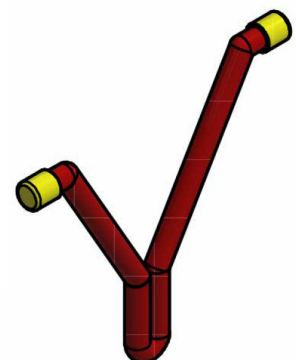

3D VIEW

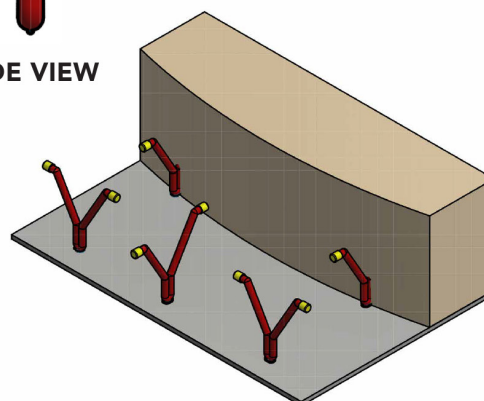

DESIGNATION

MANUFACTURED IN MILD STEEL

- 304 S/STL
- 316 S/STL
- 310 S/STL
- 253 MA

L = 25mm - 350mm

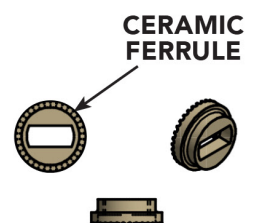

V.X.S.B

VEE WRIGGLE SADDLE BASE

NOTES

Diameters Available: 5.5mm, 8mm and 10mm

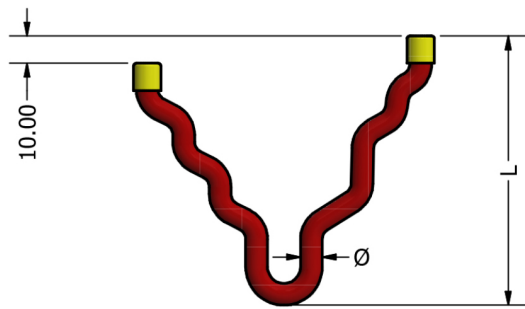

FRONT VIEW



SIDE VIEW

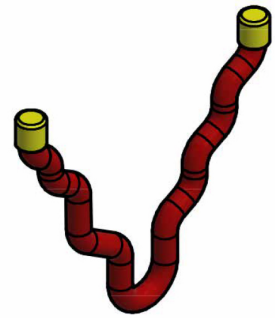

3D VIEW

DESIGNATION

MANUFACTURED IN MILD STEEL

304 S/STL

316 S/STL

310 S/STL

253 MA

L = 25mm - 350mm

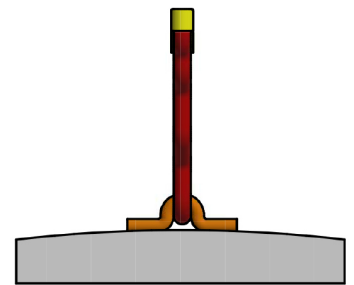
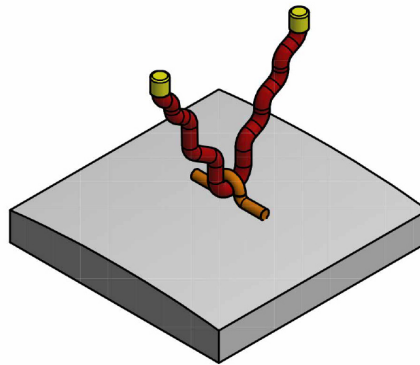

SADDLE MOUNT

V.X.D.B

VEE WRIGGLE DRILLED BASE

NOTES

Diameters Available: 5.5mm, 8mm and 10mm

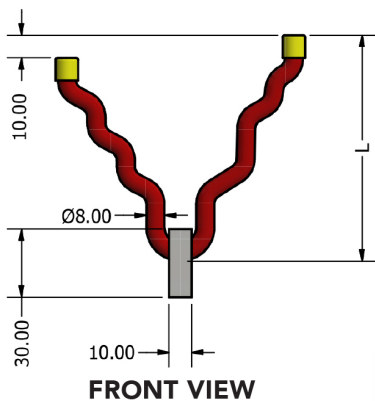

FRONT VIEW



BLACK MOUNT SIDE VIEW

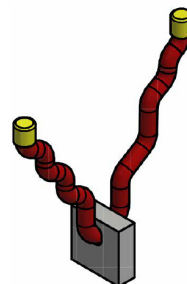

3D VIEW



STUDWELD MOUNT

DESIGNATION

MANUFACTURED IN MILD STEEL

304 S/STL

316 S/STL

310 S/STL

253 MA

L = 25mm - 350mm

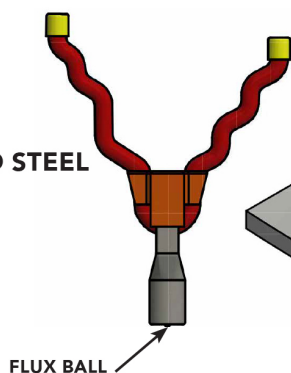

FLUX BALL

CERAMIC FERRULES

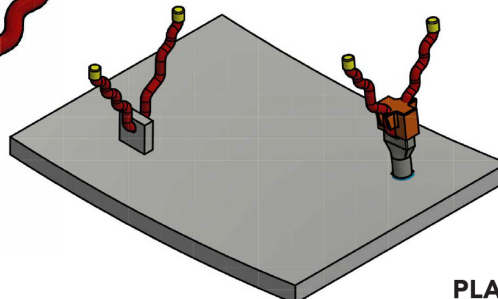

PLASTIC LOCKING CAP

SCISSOR CLIP

V.X.C

CORRUGATED ANCHOR SCISSOR CLIP

NOTES

Diameters Available: 5.5mm, 8mm

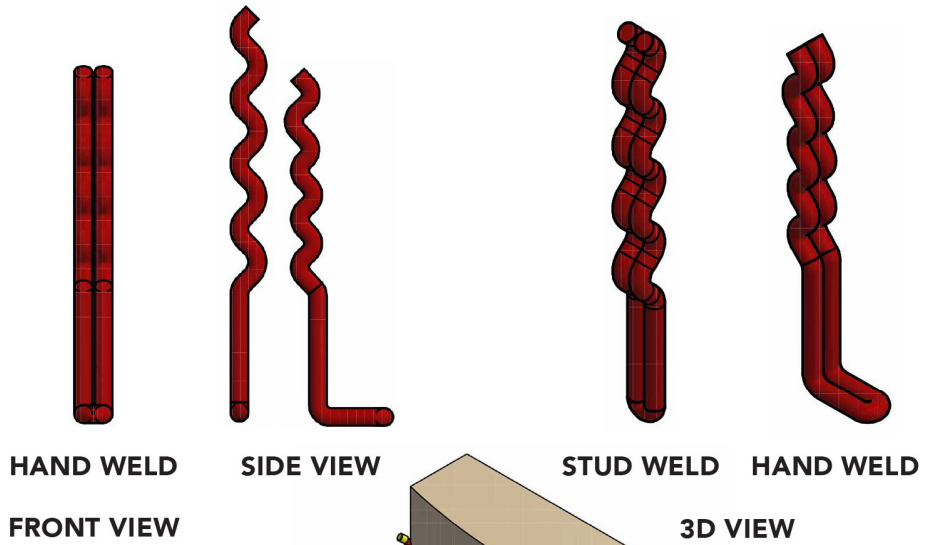
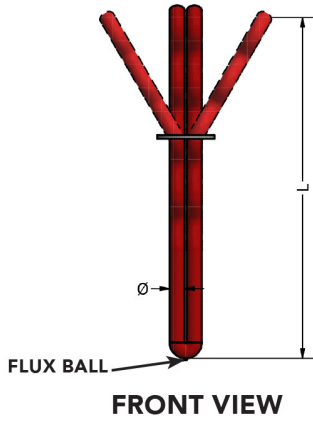

DESIGNATION

MANUFACTURED IN

- 304 S/STL
- 316 S/STL
- 310 S/STL
- 253 MA

L = 25mm - 350mm

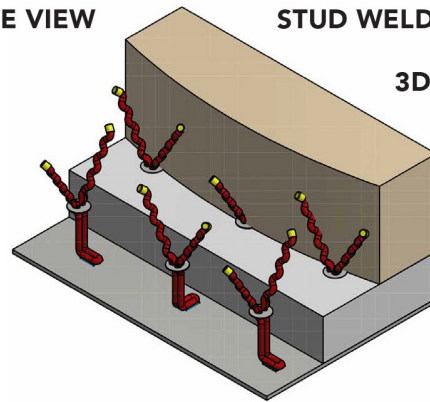
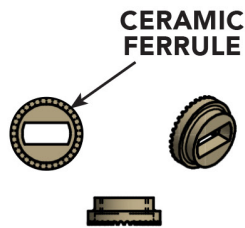

CERMAMIC BRICK HOLDER SCISSOR CLIP

NOTES

Diameters Available: 8mm and 10mm

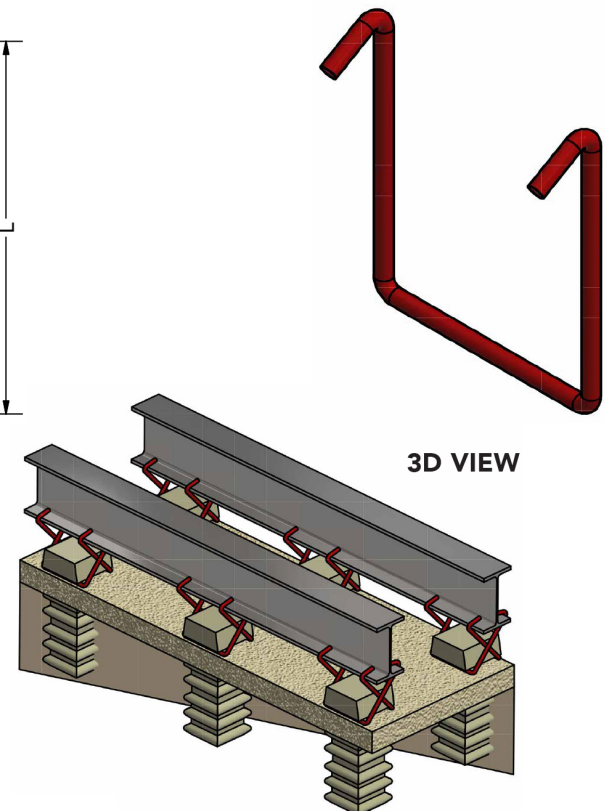
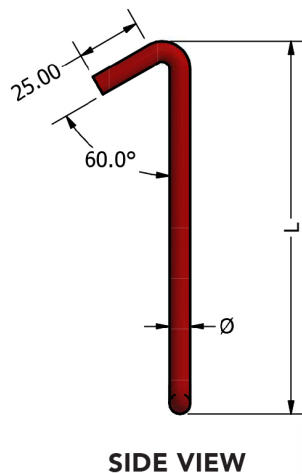
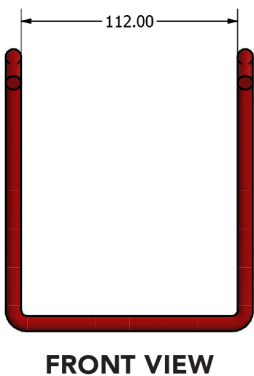

DESIGNATION

MANUFACTURED IN MILD STEEL

- 304 S/STL
- 316 S/STL
- 310 S/STL
- 253 MA

L = 25mm - 350mm

ROOF ANCHOR

V.X.S.B

HAL-HAR SUSPENSION ANCHOR

NOTES

Diameters Available: 5.5mm, 8mm, 10mm and 12mm

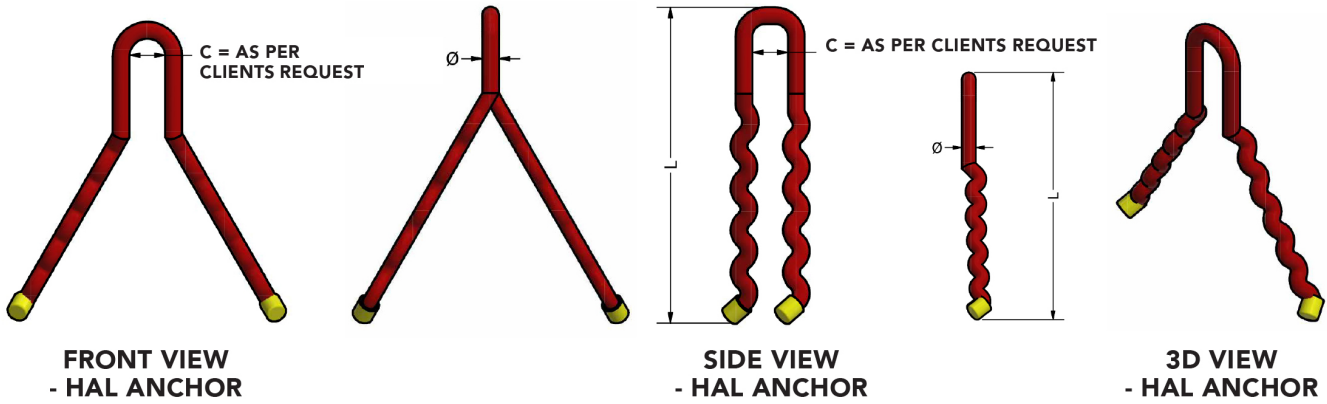

DESIGNATION

MANUFACTURED IN MILD STEEL

- 304 S/STL
- 316 S/STL
- 310 S/STL
- 253 MA

L = 25mm - 350mm

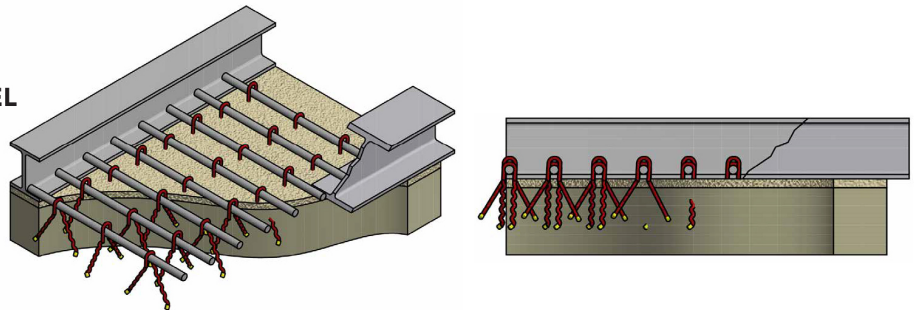

HOLD DOWN BOX ANCHOR

NOTES

Diameters Available: 5.5mm, 8mm and 10mm

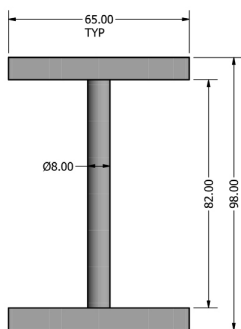

FRONT VIEW

DESIGNATION

MANUFACTURED IN MILD STEEL

- 304 S/STL
- 316 S/STL
- 310 S/STL

L = 25mm - 350mm

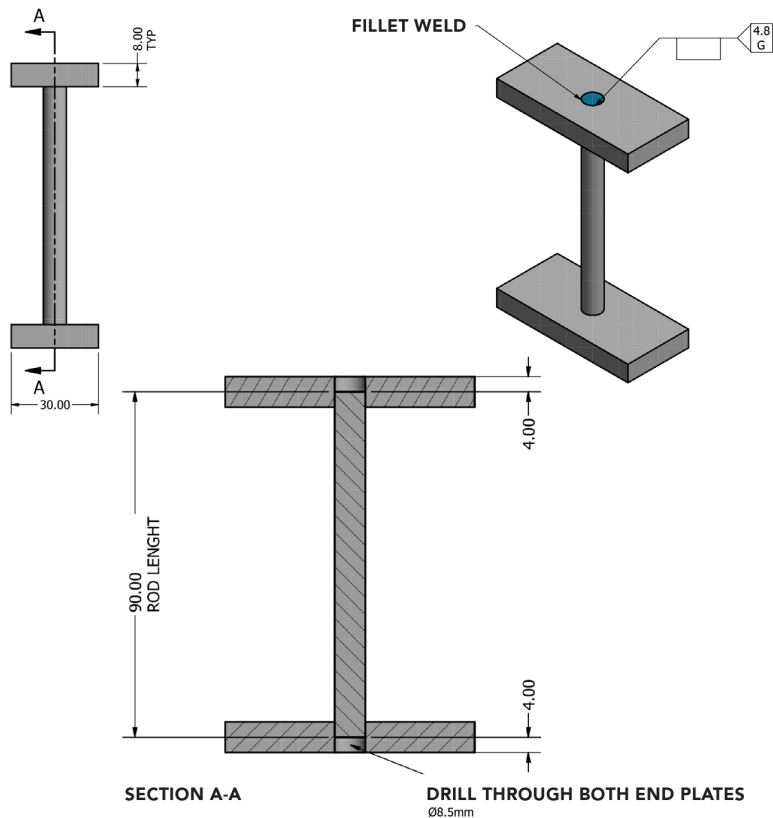

SECTION A-A

DRILL THROUGH BOTH END PLATES
Ø8.5mm

SPECIAL

ANCHOR CO1 & CO3

NOTES

Diameters Available: 5.5mm, 8mm, 10mm and 12mm

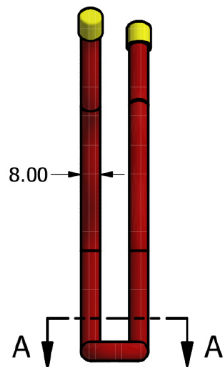

FRONT VIEW

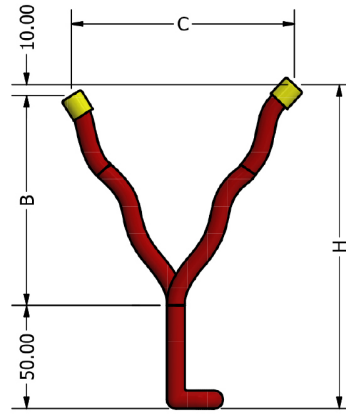

SIDE VIEW

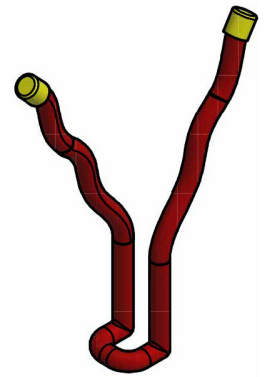

3D VIEW

DESIGNATION

MANUFACTURED IN

- 304 S/STL
- 316 S/STL
- 310 S/STL
- 253 MA

L = 25mm - 350mm

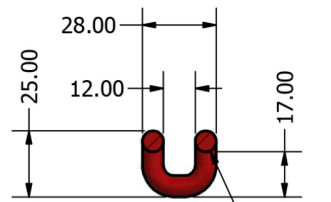

SECTION A-A

SPECIAL

ANCHOR CO2 & CO4

NOTES

Diameters Available: 5mm, 8mm, 10mm and 12mm

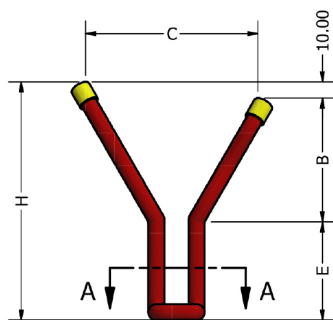

FRONT VIEW

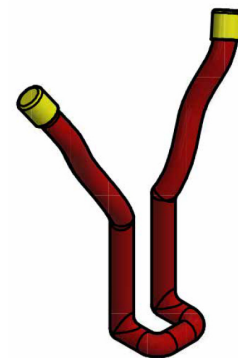
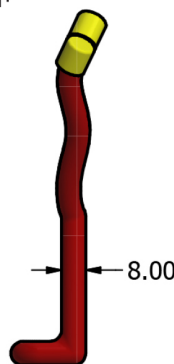

DESIGNATION

MANUFACTURED IN MILD STEEL

- 304 S/STL
- 316 S/STL
- 310 S/STL
- 253 MA

L = 25mm - 350mm

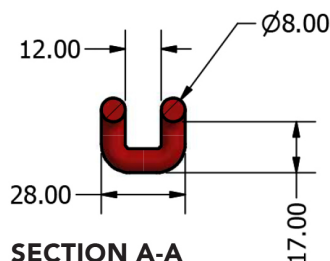

SECTION A-A

TABLE

1	2	3	4	5
ITEM	E	B	C	H
CO2	50	65	86	115
CO4	75	100	120	150

"C" CLIP

STANDARD "C" CLIP

NOTES

Diameters Available: 5.5mm, 8mm, 10mm and 12mm

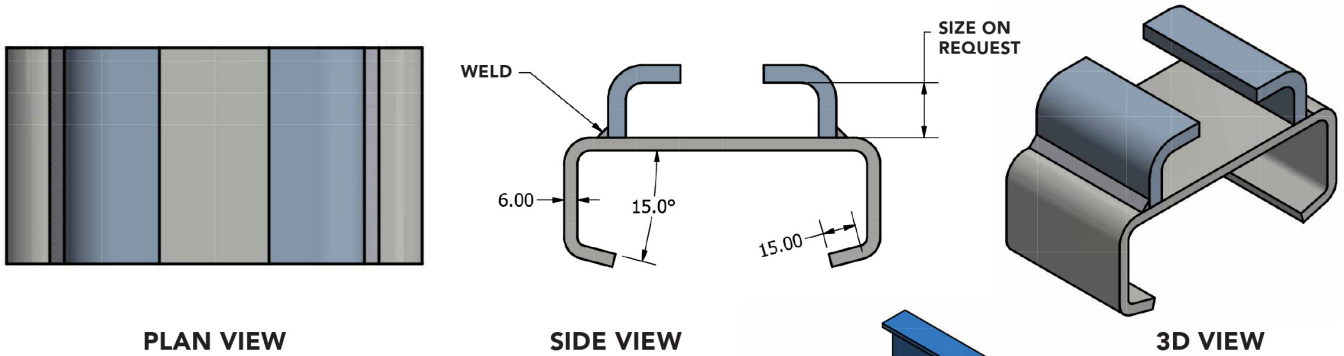

PLAN VIEW

SIDE VIEW

3D VIEW

DESIGNATION

MANUFACTURED IN MILD STEEL

304 S/STL

316 S/STL

310 S/STL

L = 25mm - 350mm

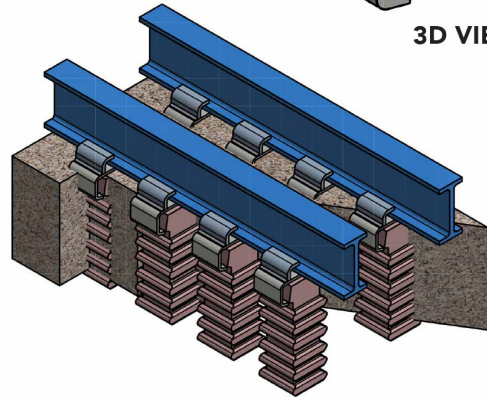

REFRACTORY ANCHORS "C" CLIP TYPES

NOTES

Diameters Available: 5.5mm, 8mm and 10mm

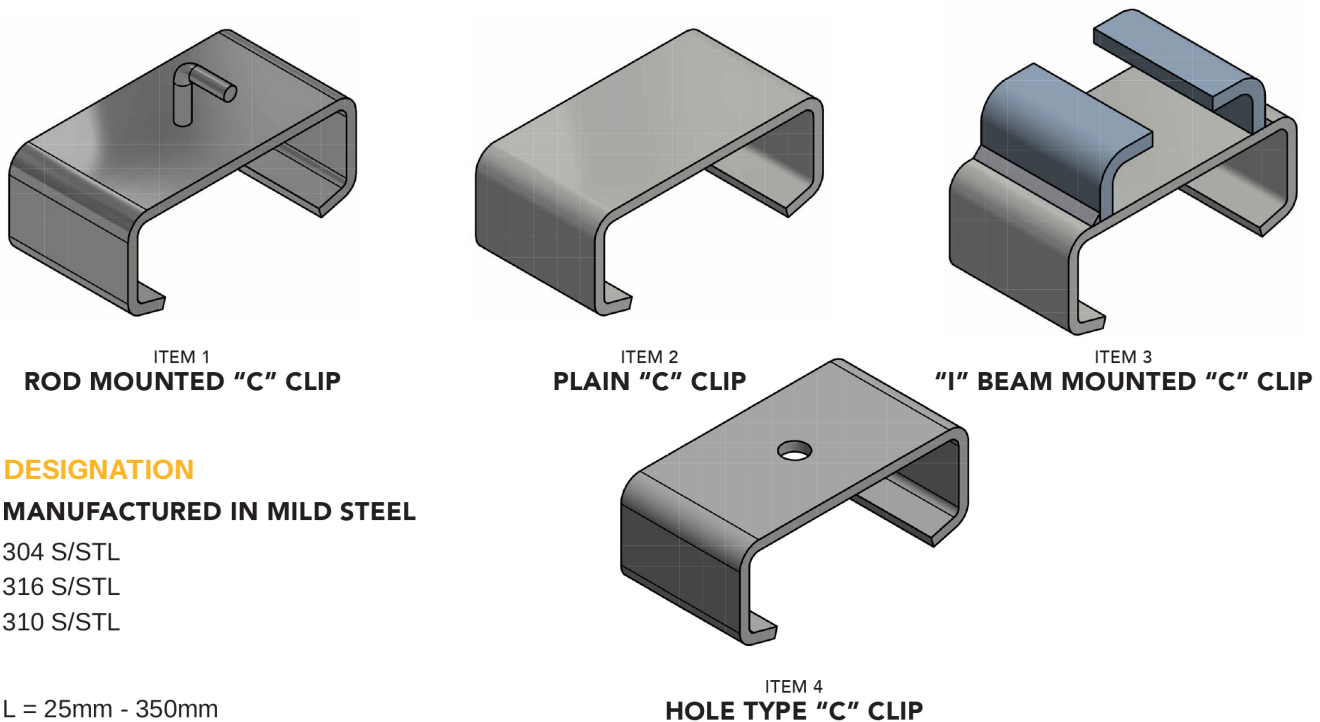

ITEM 1
ROD MOUNTED "C" CLIP

ITEM 2
PLAIN "C" CLIP

ITEM 3
"I" BEAM MOUNTED "C" CLIP

ITEM 4
HOLE TYPE "C" CLIP

DESIGNATION

MANUFACTURED IN MILD STEEL

304 S/STL

316 S/STL

310 S/STL

L = 25mm - 350mm

R6P SUSPENSION

R6P ANCHOR USED TO SUPPORT MESH

NOTES

Diameters Available: 5.5mm, 8mm, 10mm and 12mm

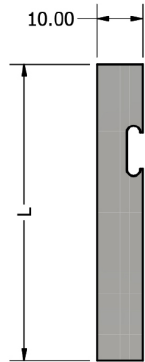

FRONT VIEW

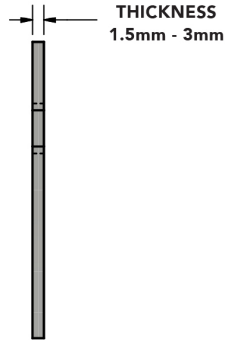

SIDE VIEW

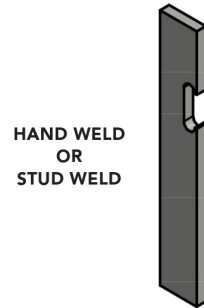

3D VIEW

DESIGNATION

MANUFACTURED IN

- 304 S/STL
- 316 S/STL
- 310 S/STL
- 253 MA

L = 25mm - 350mm

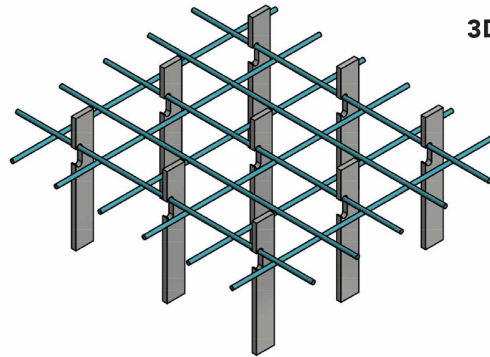

S.A. SUSPENSION ANCHOR

NOTES

Diameters Available: 5mm, 8mm, 10mm and 12mm

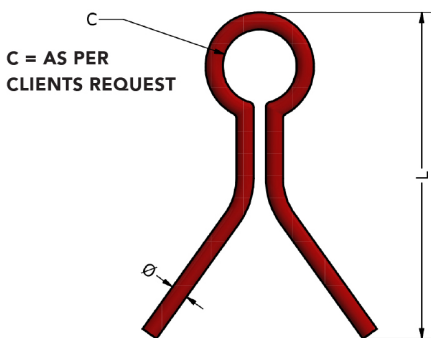

FRONT VIEW



SIDE VIEW

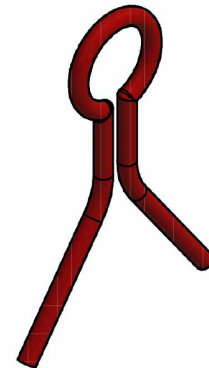

3D VIEW

DESIGNATION

MANUFACTURED IN MILD STEEL

- 304 S/STL
- 316 S/STL
- 310 S/STL
- 253 MA

L = 25mm - 350mm

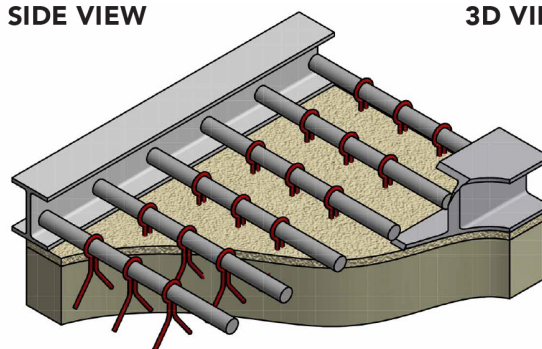

NOTES

Diameters Available: 5.5mm, 8mm, 10mm and 12mm

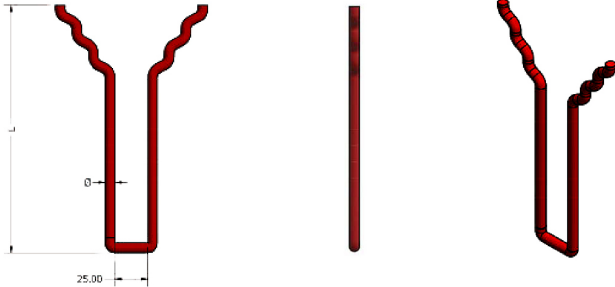

FRONT VIEW

SIDE VIEW

3D VIEW

DESIGNATION

MANUFACTURED IN MILD STEEL

- 304 S/STL
- 316 S/STL
- 310 S/STL

L = 25mm - 350mm

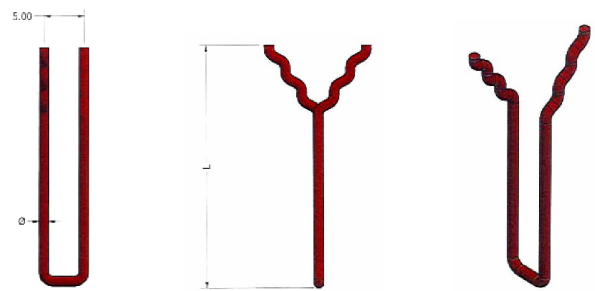

FRONT VIEW

SIDE VIEW

3D VIEW

TYPICAL ANCHOR PATTERNS

NOTES

Diameters Available: 5.5mm, 8mm and 10mm

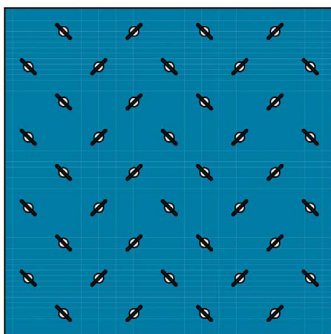

STAGGERED

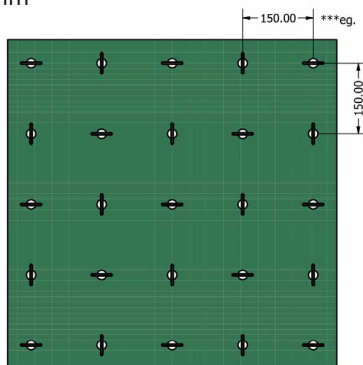

SQUARE

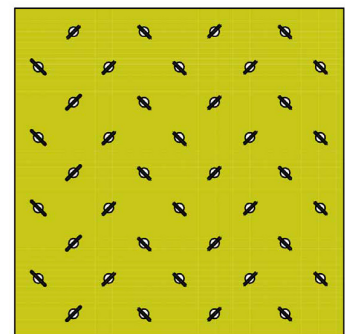

DIAMOND

DESIGNATION

MANUFACTURED IN MILD STEEL

- 304 S/STL
- 316 S/STL
- 310 S/STL
- 253 MA

L = 25mm - 350mm

***eg.

'CENTRE TO CENTRE' ANCHOR													
75	100	120	150	175	200	225	250	275	300	325	350	375	400
ANCHORS REQUIRED FOR 'SQAURE METER PATTERN'													
170	100	65	40	30	24	20	15	12	10	9	8	6	5



DGC INTERNATIONAL

E International@dgc-africa.com

2nd Floor, The AXIS,
26 Bank Street,
Cybercity,
Ebene, 72201,
Mauritius

DGC SOUTH AFRICA

Contact Person: Wynand Boshoff

T +27 16 421 3720
E sales@dgrpint.com

10 Smuts Avenue, Vereeniging,
1930, South Africa

REGIONAL OPERATIONS

DGC NORTH-WEST

Contact Person: Gawie Hugo

T +27 83 391 0531
E Northwest@dgc-africa.com

DGC KWA-ZULU NATAL

Contact Person: Denver Gounden

T +27 73 161 9913
E Kzn@dgc-africa.com

DGC LIMPOPO

Contact Person: Walter Mulovhedzi

T +27 76 896 7676
E Limpopo@dgc-africa.com

DGC ZAMBIA

Contact Person: Warren du Plessis

T +260 761 83 2470
T +27 82 319 8005
E Zambia@dgc-africa.com

Plot 2394, Freedom Way,
Mufulira

DGC DEMOCRATIC REPUBLIC OF CONGO

Contact Person: Warren du Plessis

T +243 8996 49 493
T +27 82 319 8005
E DRC@dgc-africa.com

Kolwezi Office:

118 Avenue Kalima, Quartier Mutoshi,
Commune Manika / Kolwezi

Lubumbashi Office:

199 Avenue Mubanzo Quartier; Golf Malela.
Commune Lubumbashi,
Province du Haut-Katanga, République
démocratique du Congo

DGC MADAGASCAR

Contact Person: Abizar Pichori

T +261 32 112 2122
E Madagascar@dgc-africa.com

Lot Ivx 30 Bis Ankazomanga rue
Dr Raseta Antananarivo, 101,
Madagascar

DGC ZIMBABWE

Contact Person: Douglas Mhazo

T +263 772 514 480
E Zimbabwe@dgc-africa.com

311 Esap Way, Willowvale
Harare, Zimbabwe

OUR OFFICES

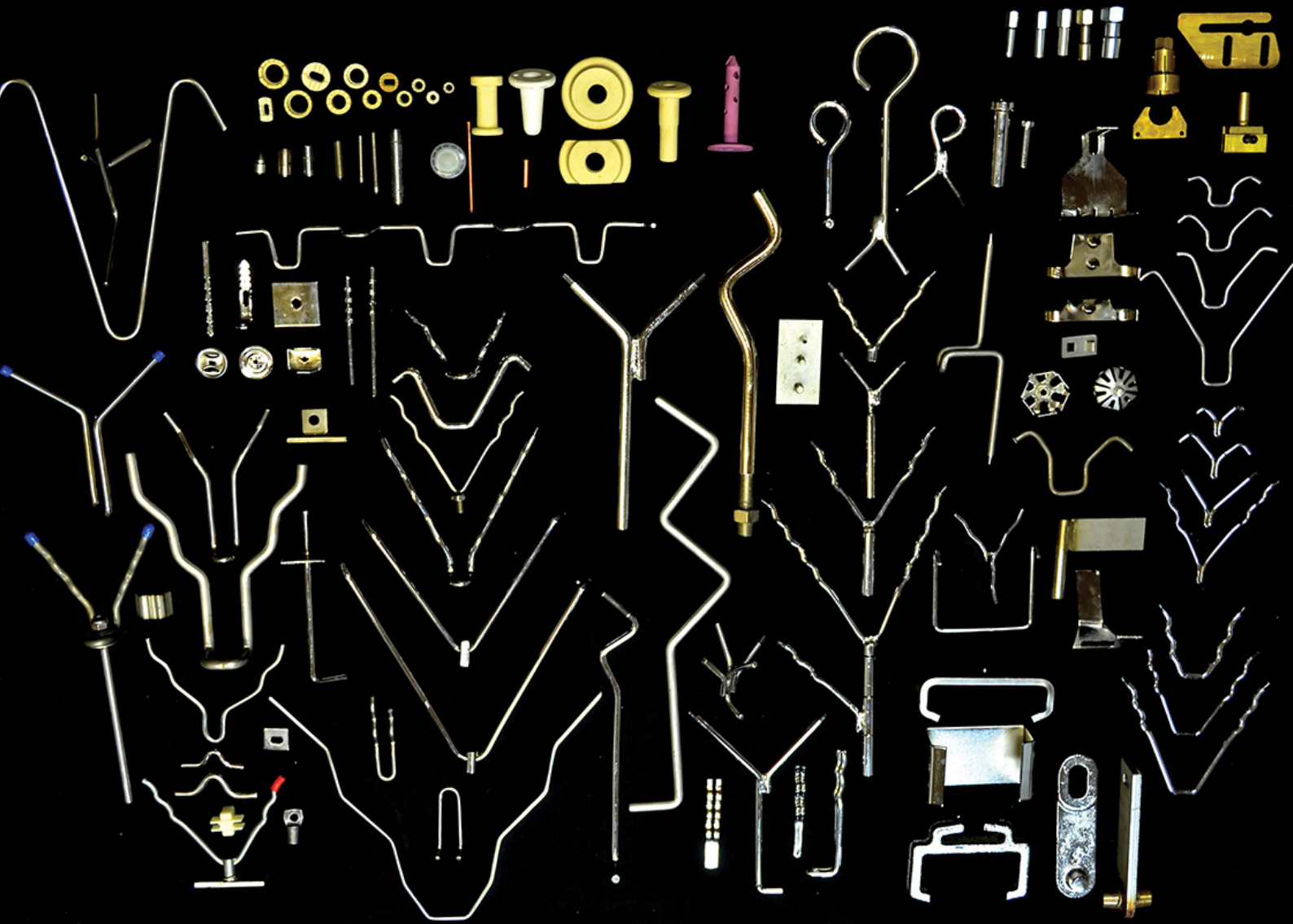

**CONTACT US TODAY
FOR ALL YOUR REFRACTORY ANCHOR NEEDS**

T +27 16 421 3720 **E** contactus@dgc-africa.com

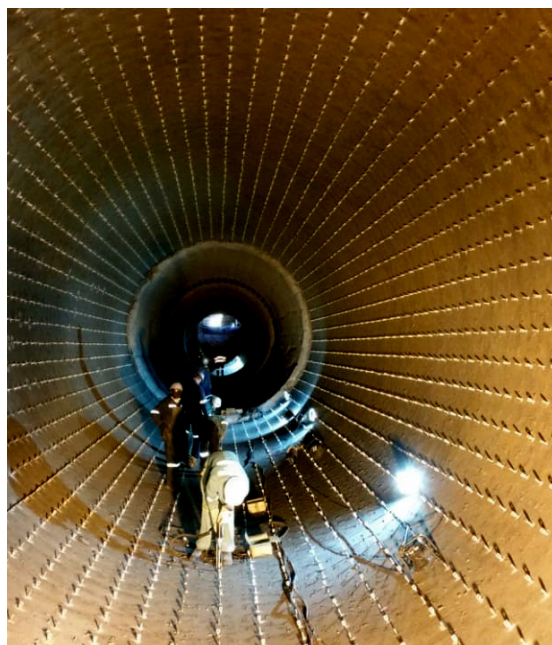
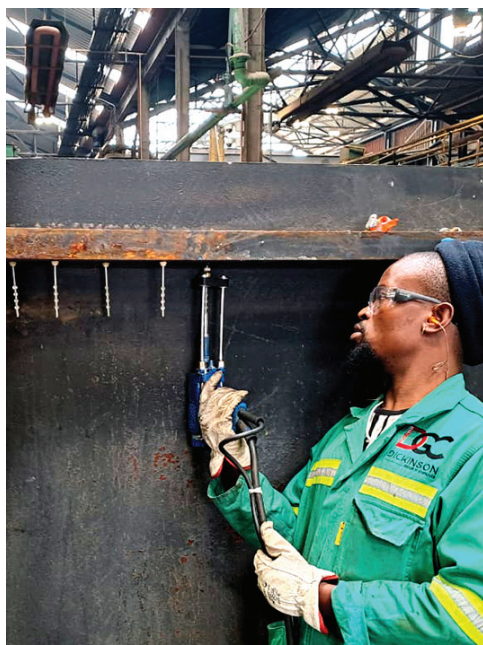



www.dgc-africa.com